

# IRGIB15B60KD1

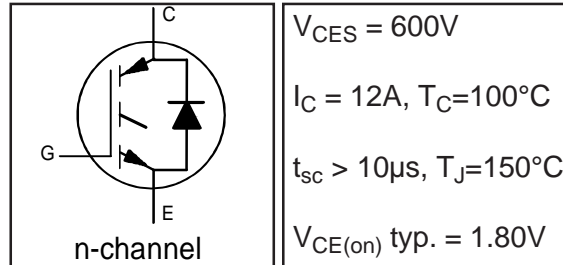
## INSULATED GATE BIPOLAR TRANSISTOR WITH ULTRAFAST SOFT RECOVERY DIODE

### Features

- Low VCE (on) Non Punch Through IGBT Technology.
- Low Diode VF.
- 10µs Short Circuit Capability.
- Square RBSOA.
- Ultrasoft Diode Reverse Recovery Characteristics.
- Positive VCE (on) Temperature Coefficient.
- Maximum Junction Temperature Rated at 175°C

### Benefits

- Benchmark Efficiency for Motor Control.
- Rugged Transient Performance.
- Low EMI.
- Excellent Current Sharing in Parallel Operation.



### Absolute Maximum Ratings

	Parameter	Max.	Units
$V_{CES}$	Collector-to-Emitter Voltage	600	V
$I_C @ T_C = 25^\circ C$	Continuous Collector Current	19	A
$I_C @ T_C = 100^\circ C$	Continuous Collector Current	12	
$I_{CM}$	Pulse Collector Current (Ref.Fig.C.T.5)	38	
$I_{LM}$	Clamped Inductive Load current ①	38	
$I_F @ T_C = 25^\circ C$	Diode Continuous Forward Current	19	
$I_F @ T_C = 100^\circ C$	Diode Continuous Forward Current	12	
$I_{FM}$	Diode Maximum Forward Current	38	V
$V_{ISOL}$	RMS Isolation Voltage, Terminal to Case, $t = 1 \text{ min}$	2500	
$V_{GE}$	Gate-to-Emitter Voltage	$\pm 20$	W
$P_D @ T_C = 25^\circ C$	Maximum Power Dissipation	52	
$P_D @ T_C = 100^\circ C$	Maximum Power Dissipation	26	°C
$T_J$	Operating Junction and	-55 to +175	
$T_{STG}$	Storage Temperature Range		
	Soldering Temperature for 10 sec.	300 (0.063 in. (1.6mm) from case)	
	Mounting Torque, 6-32 or M3 Screw	10 lbf.in (1.1N.m)	

### Thermal / Mechanical Characteristics

	Parameter	Min.	Typ.	Max.	Units
$R_{\theta JC}$	Junction-to-Case- IGBT	—	—	2.9	°C/W
$R_{\theta JC}$	Junction-to-Case- Diode	—	—	4.6	
$R_{\theta CS}$	Case-to-Sink, flat, greased surface	—	0.50	—	
$R_{\theta JA}$	Junction-to-Ambient, typical socket mount	—	—	62	
Wt	Weight	—	2.0	—	g

# IRGIB15B60KD1

Electrical Characteristics @  $T_J = 25^\circ\text{C}$  (unless otherwise specified)

International  
IR Rectifier

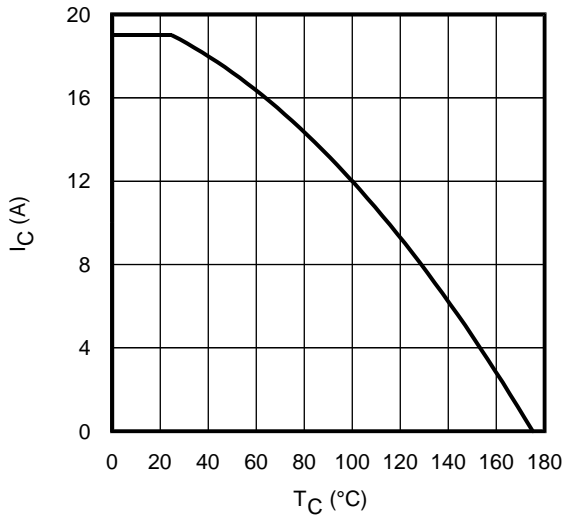
	Parameter	Min.	Typ.	Max.	Units	Conditions	Ref.Fig.
$V_{(BR)CES}$	Collector-to-Emitter Breakdown Voltage	600	—	—	V	$V_{GE} = 0V, I_C = 500\mu A$	
$\Delta V_{(BR)CES}/\Delta T_J$	Temperature Coeff. of Breakdown Voltage	—	0.32	—	V/ $^\circ\text{C}$	$V_{GE} = 0V, I_C = 1mA (25^\circ\text{C}-150^\circ\text{C})$	
$V_{CE(on)}$	Collector-to-Emitter Voltage	—	1.80	2.20	V	$I_C = 15A, V_{GE} = 15V, T_J = 25^\circ\text{C}$	5,6,7
		—	2.05	2.50		$I_C = 15A, V_{GE} = 15V, T_J = 150^\circ\text{C}$	9,10,11
		—	2.10	2.60		$I_C = 15A, V_{GE} = 15V, T_J = 175^\circ\text{C}$	
$V_{GE(th)}$	Gate Threshold Voltage	3.5	4.5	5.5	V	$V_{CE} = V_{GE}, I_C = 250\mu A$	9,10,11
$\Delta V_{GE(th)}/\Delta T_J$	Threshold Voltage temp. coefficient	—	-10	—	mV/ $^\circ\text{C}$	$V_{CE} = V_{GE}, I_C = 1mA (25^\circ\text{C}-150^\circ\text{C})$	12
gfe	Forward Transconductance	—	10	—	S	$V_{CE} = 50V, I_C = 15A, PW = 80\mu s$	
$I_{CES}$	Zero Gate Voltage Collector Current	—	1.0	150	$\mu A$	$V_{GE} = 0V, V_{CE} = 600V$	
		—	163	500		$V_{GE} = 0V, V_{CE} = 600V, T_J = 150^\circ\text{C}$	
		—	829	1800		$V_{GE} = 0V, V_{CE} = 600V, T_J = 175^\circ\text{C}$	
$V_{FM}$	Diode Forward Voltage Drop	—	1.69	2.30	V	$I_F = 15A, V_{GE} = 0V$	8
		—	1.31	1.75		$I_F = 15A, V_{GE} = 0V, T_J = 150^\circ\text{C}$	
		—	1.25	1.65		$I_F = 15A, V_{GE} = 0V, T_J = 175^\circ\text{C}$	
$I_{GES}$	Gate-to-Emitter Leakage Current	—	—	$\pm 100$	nA	$V_{GE} = \pm 20V, V_{CE} = 0V$	

## Switching Characteristics @ $T_J = 25^\circ\text{C}$ (unless otherwise specified)

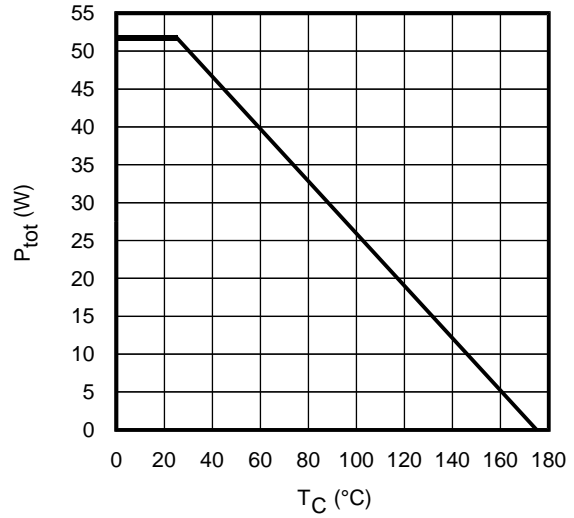
	Parameter	Min.	Typ.	Max.	Units	Conditions	Ref.Fig.
$Q_g$	Total Gate Charge (turn-on)	—	56	84	nC	$I_C = 15A$ $V_{CC} = 400V$ $V_{GE} = 15V$	23
$Q_{ge}$	Gate-to-Emitter Charge (turn-on)	—	7.0	10			CT1
$Q_{gc}$	Gate-to-Collector Charge (turn-on)	—	26	39			
$E_{on}$	Turn-On Switching Loss	—	127	140	$\mu J$	$I_C = 15A, V_{CC} = 400V$ $V_{GE} = 15V, R_G = 22\Omega, L = 1.07mH$ $L_S = 150nH, T_J = 25^\circ\text{C} \textcircled{1}$	CT4
$E_{off}$	Turn-Off Switching Loss	—	334	422			
$E_{tot}$	Total Switching Loss	—	461	556			
$t_{d(on)}$	Turn-On delay time	—	30	39	ns	$I_C = 15A, V_{CC} = 400V$ $V_{GE} = 15V, R_G = 22\Omega, L = 1.07mH$ $L_S = 150nH, T_J = 25^\circ\text{C}$	CT4
$t_r$	Rise time	—	25	35			
$t_{d(off)}$	Turn-Off delay time	—	173	188			
$t_f$	Fall time	—	41	53			
$E_{on}$	Turn-On Switching Loss	—	258	282	$\mu J$	$I_C = 15A, V_{CC} = 400V$ $V_{GE} = 15V, R_G = 22\Omega, L = 1.07mH$ $L_S = 150nH, T_J = 150^\circ\text{C} \textcircled{2}$	CT4
$E_{off}$	Turn-Off Switching Loss	—	570	646			13,15
$E_{tot}$	Total Switching Loss	—	829	915			WF1,WF2
$t_{d(on)}$	Turn-On delay time	—	30	39			14,16
$t_r$	Rise time	—	25	35	ns	$V_{GE} = 15V, R_G = 22\Omega, L = 1.07mH$ $L_S = 150nH, T_J = 150^\circ\text{C}$	CT4
$t_{d(off)}$	Turn-Off delay time	—	194	207			WF1
$t_f$	Fall time	—	56	73			WF2
$L_E$	Internal Emitter Inductance	—	7.5	—			nH
$C_{ies}$	Input Capacitance	—	850	1275	pF	$V_{GE} = 0V$ $V_{CC} = 30V$ $f = 1.0MHz$	22
$C_{oes}$	Output Capacitance	—	100	150			
$C_{res}$	Reverse Transfer Capacitance	—	32	48			
RBSOA	Reverse Bias Safe Operating Area	FULL SQUARE				$T_J = 150^\circ\text{C}, I_C = 38A, V_p = 600V$ $V_{CC} = 500V, V_{GE} = +15V \text{ to } 0V, R_G = 22\Omega$	4 CT2
SCSOA	Short Circuit Safe Operating Area	10	—	—	$\mu s$	$T_J = 150^\circ\text{C}, V_p = 600V, R_G = 22\Omega$ $V_{CC} = 360V, V_{GE} = +15V \text{ to } 0V$	CT3 WF4
$I_{SC(PEAK)}$	Peak Short Circuit Collector Current	—	140	—	A		WF4
$E_{rec}$	Reverse Recovery Energy of the Diode	—	267	347	$\mu J$	$T_J = 150^\circ\text{C}$	17,18,19
$t_{rr}$	Diode Reverse Recovery Time	—	67	87	ns	$V_{CC} = 400V, I_F = 15A, L = 1.07mH$	20,21
$I_{rr}$	Peak Reverse Recovery Current	—	23	30	A	$V_{GE} = 15V, R_G = 22\Omega$	CT4,WF3
$Q_{rr}$	Diode Reverse Recovery Charge	—	984	1279	nC	$di/dt = 875A/\mu s$	

$\textcircled{1} V_{CC} = 80\% (V_{CES}), V_{GE} = 20V, L = 100\mu H, R_G = 22\Omega.$

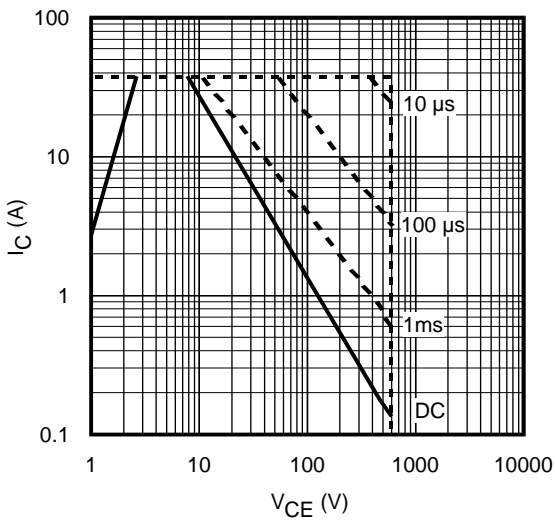
$\textcircled{2}$  Energy losses include "tail" and diode reverse recovery.



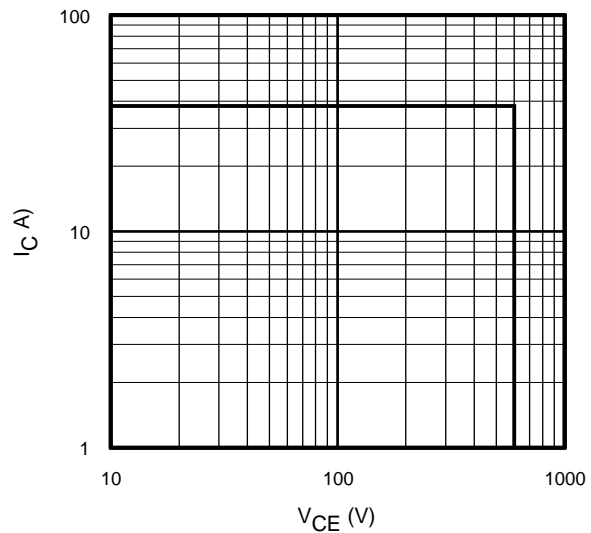
**Fig. 1** - Maximum DC Collector Current vs. Case Temperature



**Fig. 2** - Power Dissipation vs. Case Temperature

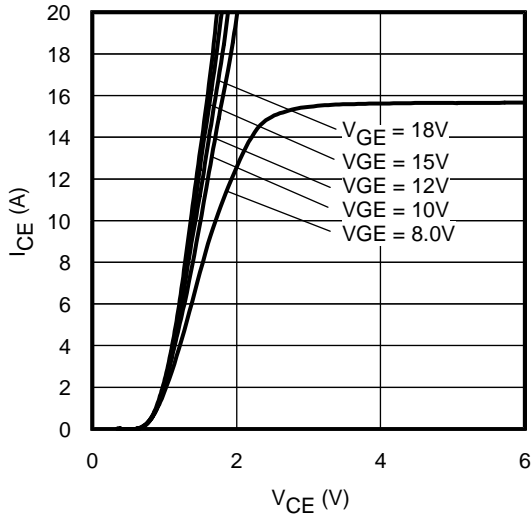


**Fig. 3** - Forward SOA  
 $T_C = 25^{\circ}C$ ;  $T_J \leq 150^{\circ}C$

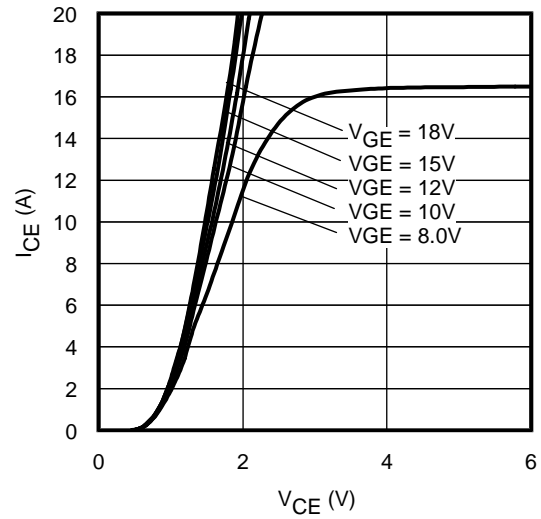


**Fig. 4** - Reverse Bias SOA  
 $T_J = 150^{\circ}C$ ;  $V_{GE} = 15V$

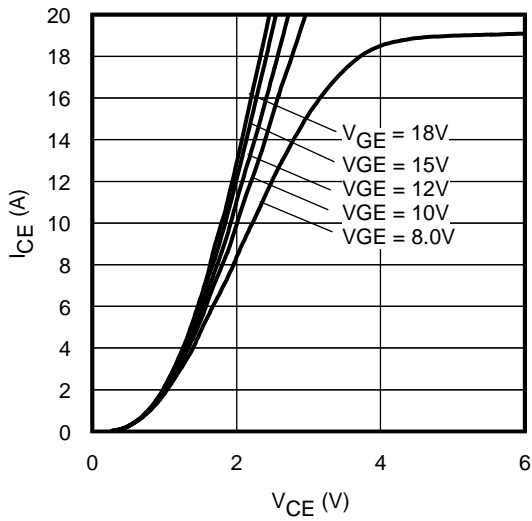
# IRGIB15B60KD1



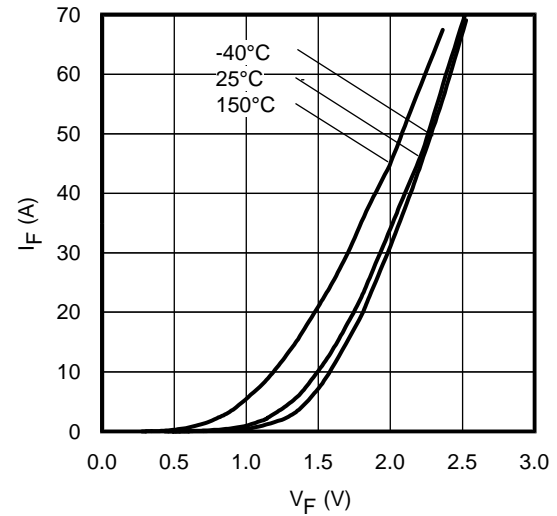
**Fig. 5** - Typ. IGBT Output Characteristics  
 $T_J = -40^\circ\text{C}$ ;  $t_p = 60\mu\text{s}$



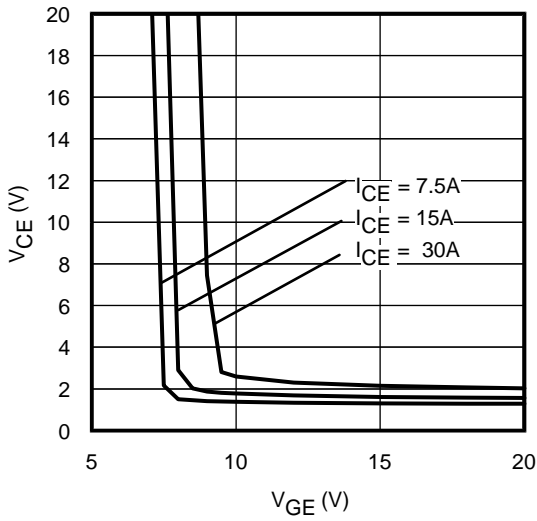
**Fig. 6** - Typ. IGBT Output Characteristics  
 $T_J = 25^\circ\text{C}$ ;  $t_p = 60\mu\text{s}$



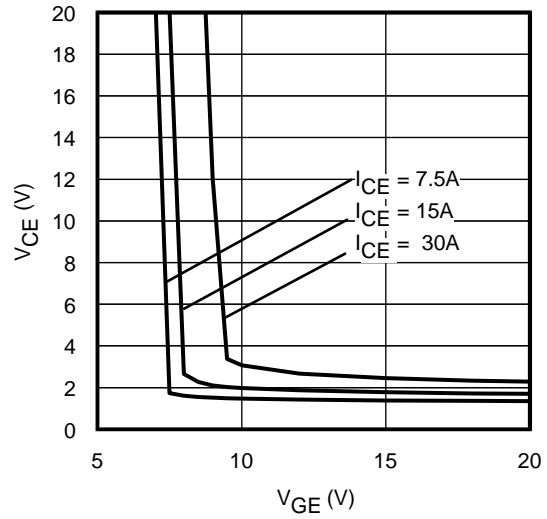
**Fig. 7** - Typ. IGBT Output Characteristics  
 $T_J = 150^\circ\text{C}$ ;  $t_p = 60\mu\text{s}$



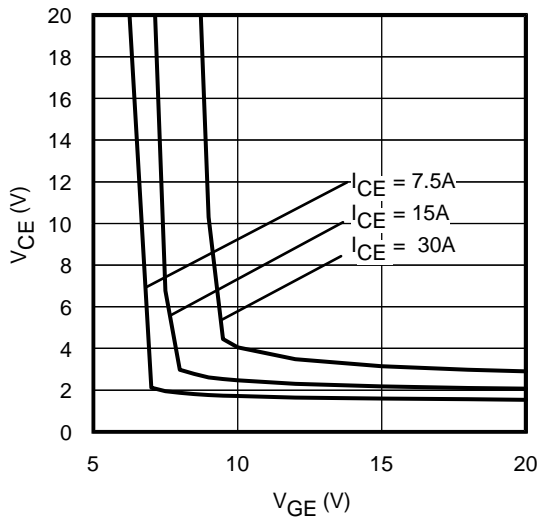
**Fig. 8** - Typ. Diode Forward Characteristics  
 $t_p = 60\mu\text{s}$



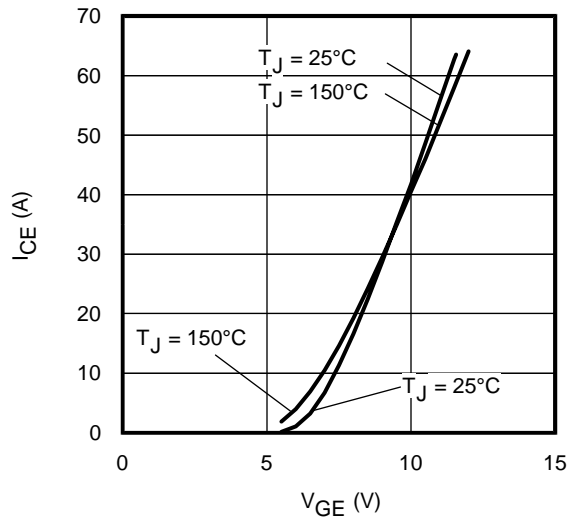
**Fig. 9** - Typical  $V_{CE}$  vs.  $V_{GE}$   
 $T_J = -40^\circ\text{C}$



**Fig. 10** - Typical  $V_{CE}$  vs.  $V_{GE}$   
 $T_J = 25^\circ\text{C}$

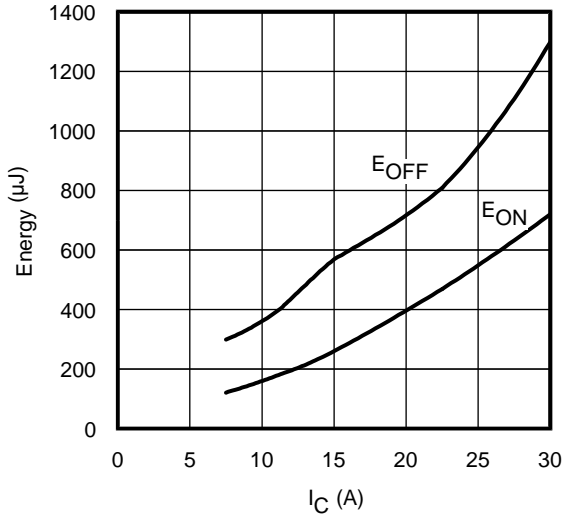


**Fig. 11** - Typical  $V_{CE}$  vs.  $V_{GE}$   
 $T_J = 150^\circ\text{C}$

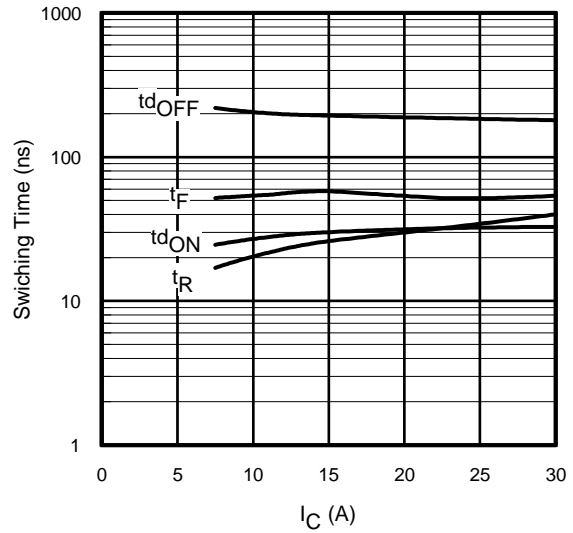


**Fig. 12** - Typ. Transfer Characteristics  
 $V_{CE} = 50\text{V}$ ;  $t_p = 10\mu\text{s}$

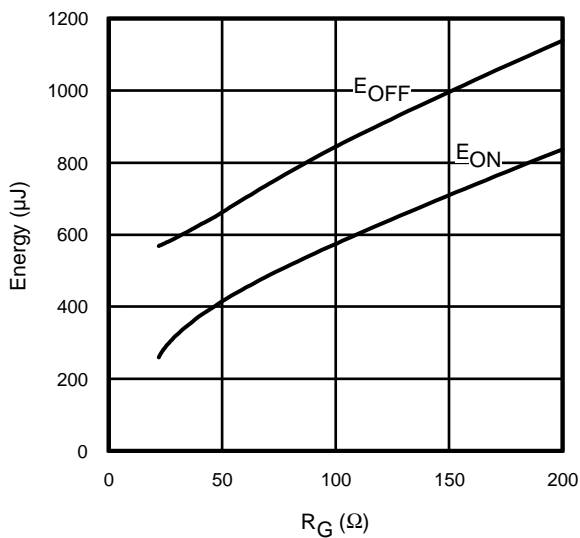
# IRGIB15B60KD1



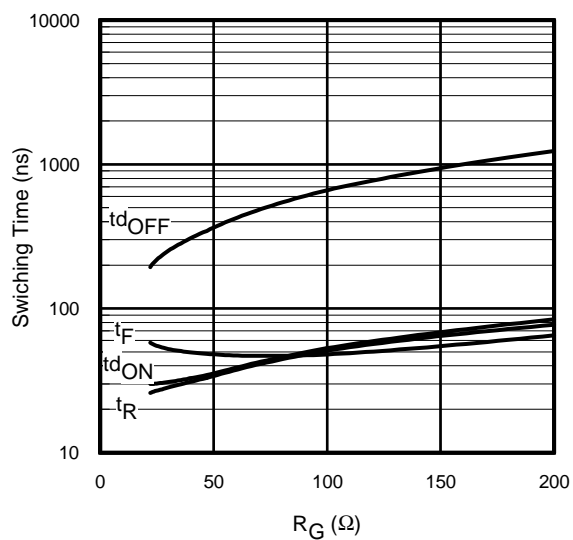
**Fig. 13** - Typ. Energy Loss vs.  $I_C$   
 $T_J = 150^\circ\text{C}$ ;  $L=1.07\text{mH}$ ;  $V_{CE}= 400\text{V}$   
 $R_G= 22\Omega$ ;  $V_{GE}= 15\text{V}$



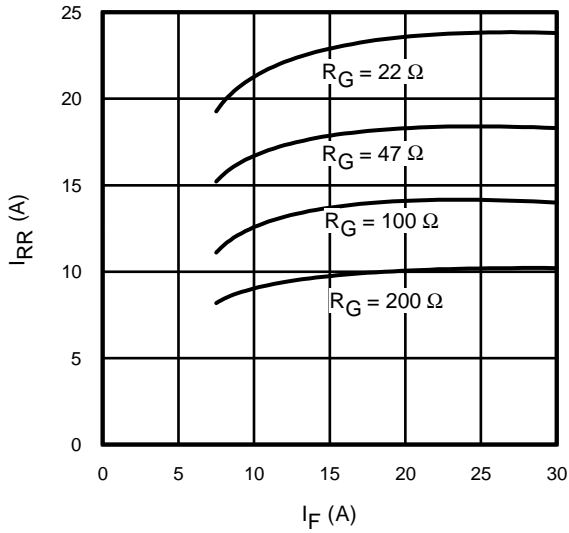
**Fig. 14** - Typ. Switching Time vs.  $I_C$   
 $T_J = 150^\circ\text{C}$ ;  $L=1.07\text{mH}$ ;  $V_{CE}= 400\text{V}$   
 $R_G= 22\Omega$ ;  $V_{GE}= 15\text{V}$



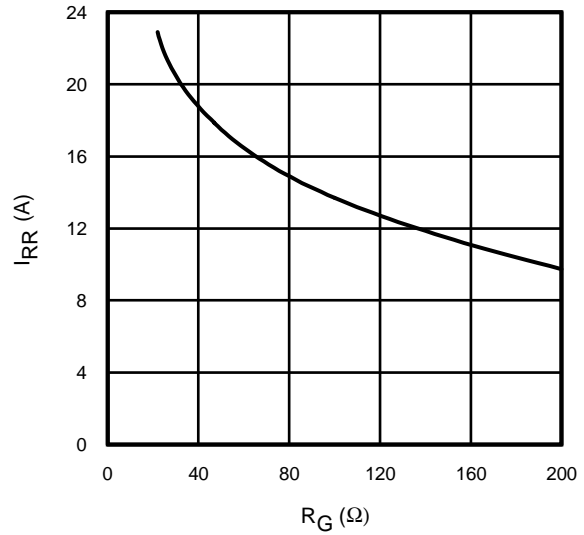
**Fig. 15** - Typ. Energy Loss vs.  $R_G$   
 $T_J = 150^\circ\text{C}$ ;  $L=1.07\text{mH}$ ;  $V_{CE}= 400\text{V}$   
 $I_{CE}= 15\text{A}$ ;  $V_{GE}= 15\text{V}$



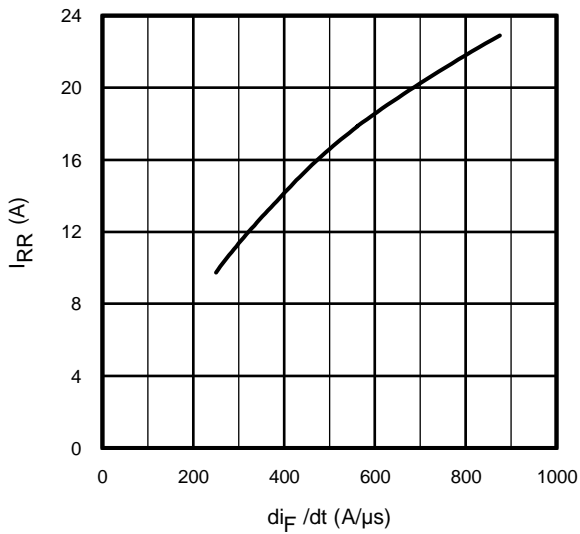
**Fig. 16** - Typ. Switching Time vs.  $R_G$   
 $T_J = 150^\circ\text{C}$ ;  $L=1.07\text{mH}$ ;  $V_{CE}= 400\text{V}$   
 $I_{CE}= 15\text{A}$ ;  $V_{GE}= 15\text{V}$



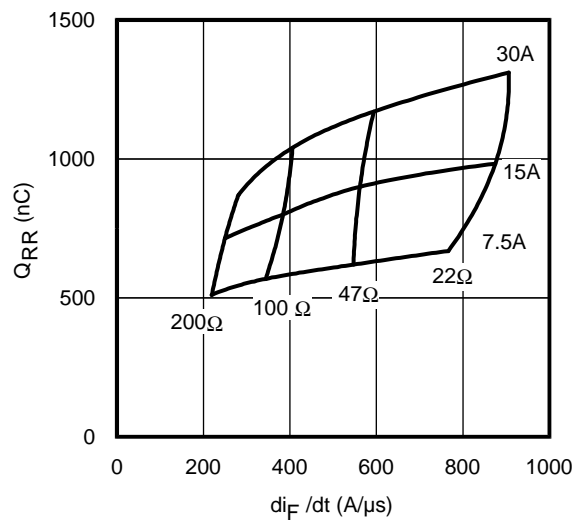
**Fig. 17** - Typical Diode  $I_{RR}$  vs.  $I_F$   
 $T_J = 150^\circ\text{C}$



**Fig. 18** - Typical Diode  $I_{RR}$  vs.  $R_G$   
 $T_J = 150^\circ\text{C}$ ;  $I_F = 15\text{A}$

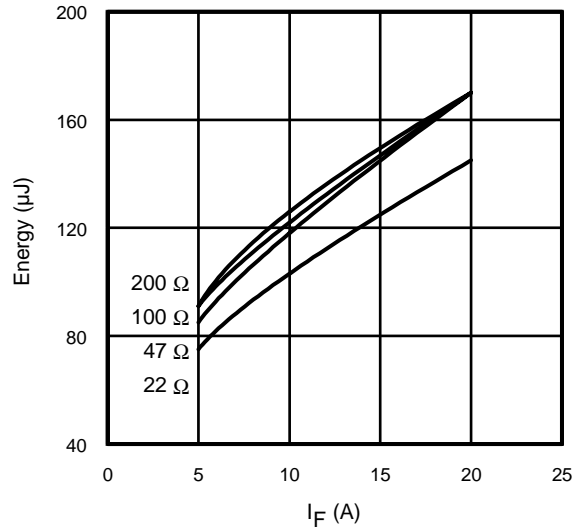


**Fig. 19**- Typical Diode  $I_{RR}$  vs.  $di_F/dt$   
 $V_{CC} = 400\text{V}$ ;  $V_{GE} = 15\text{V}$ ;  
 $I_{CE} = 15\text{A}$ ;  $T_J = 150^\circ\text{C}$

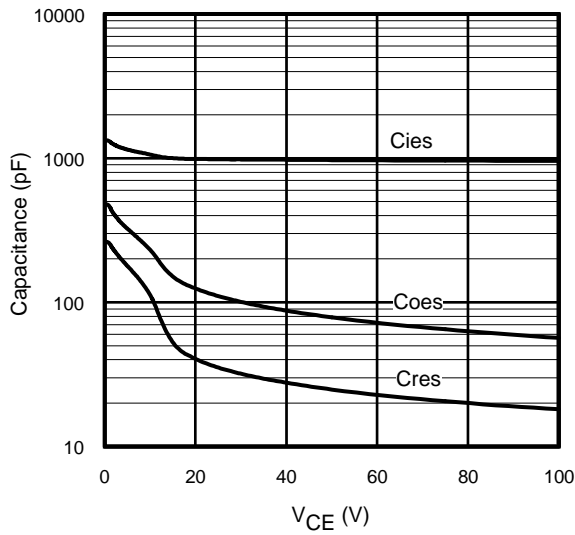


**Fig. 20** - Typical Diode  $Q_{RR}$   
 $V_{CC} = 400\text{V}$ ;  $V_{GE} = 15\text{V}$ ;  $T_J = 150^\circ\text{C}$

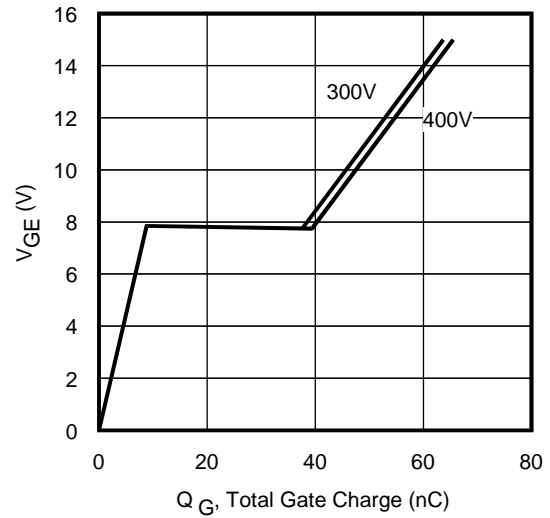
# IRGIB15B60KD1



**Fig. 21** - Typical Diode  $E_{RR}$  vs.  $I_F$   
 $T_J = 150^\circ\text{C}$



**Fig. 22**- Typ. Capacitance vs.  $V_{CE}$   
 $V_{GE} = 0\text{V}$ ;  $f = 1\text{MHz}$



**Fig. 23** - Typical Gate Charge vs.  $V_{GE}$   
 $I_{CE} = 15\text{A}$ ;  $L = 2500\mu\text{H}$



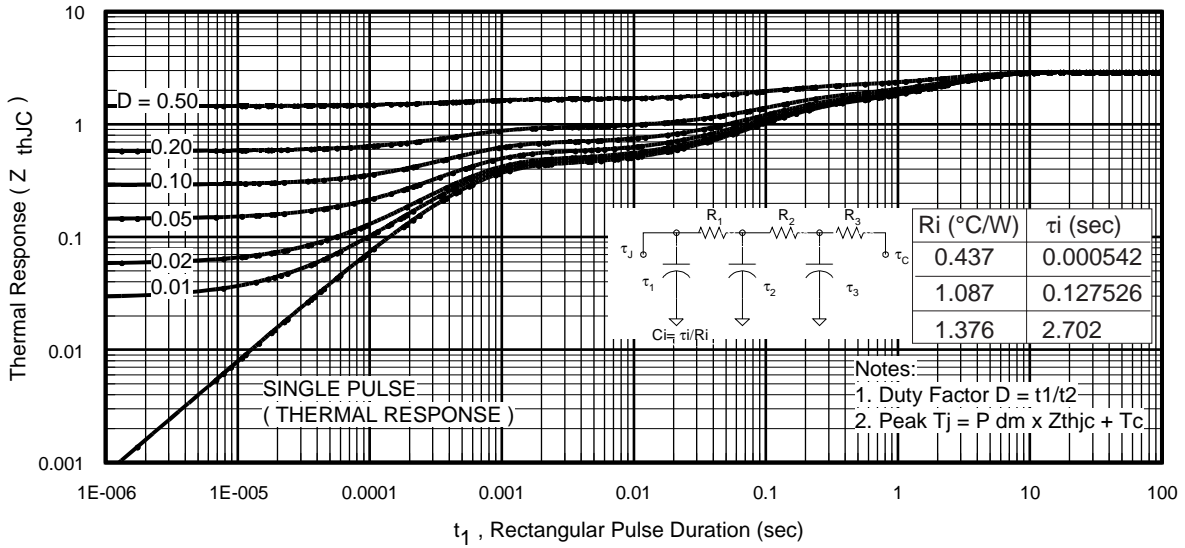


Fig 24. Maximum Transient Thermal Impedance, Junction-to-Case (IGBT)

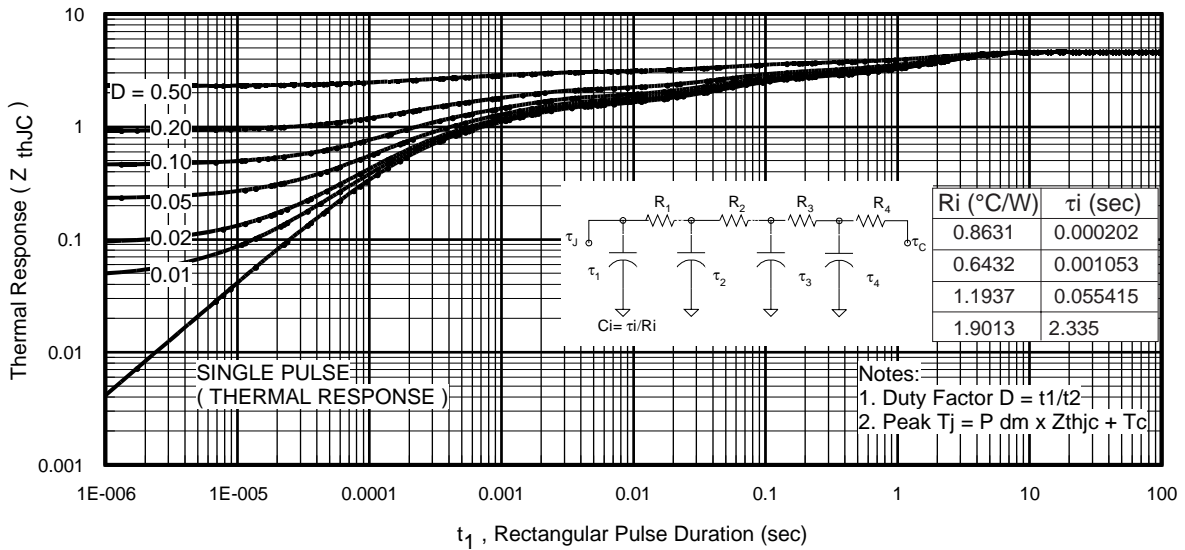
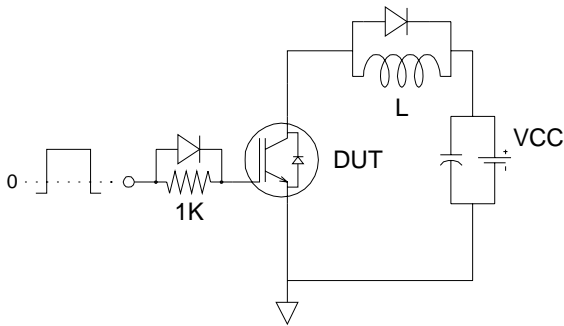


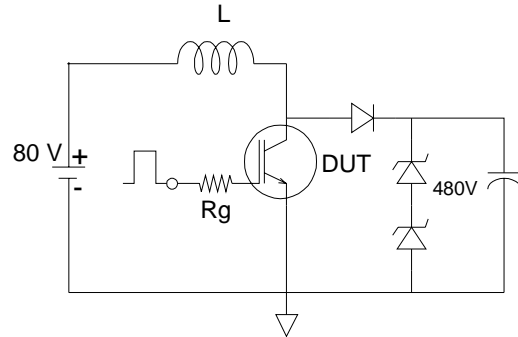
Fig 25. Maximum Transient Thermal Impedance, Junction-to-Case (DIODE)

# IRGIB15B60KD1

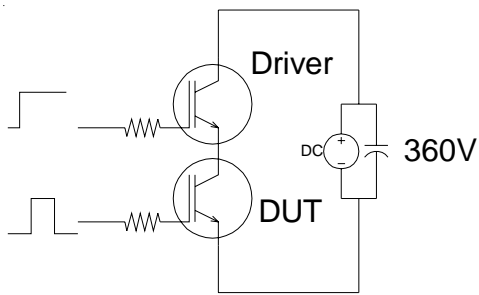
International  
**IR** Rectifier



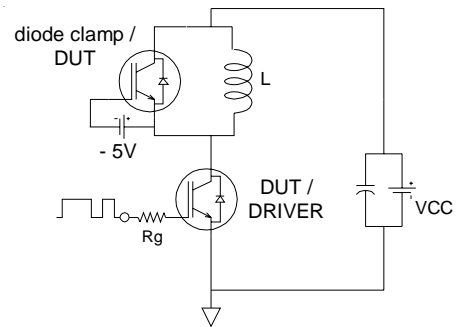
**Fig.C.T.1 - Gate Charge Circuit (turn-off)**



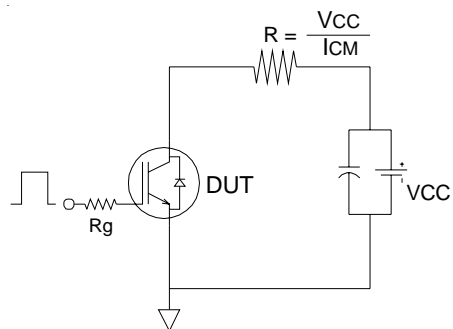
**Fig.C.T.2 - RBSOA Circuit**



**Fig.C.T.3 - S.C.SOA Circuit**



**Fig.C.T.4 - Switching Loss Circuit**



**Fig.C.T.5 - Resistive Load Circuit**

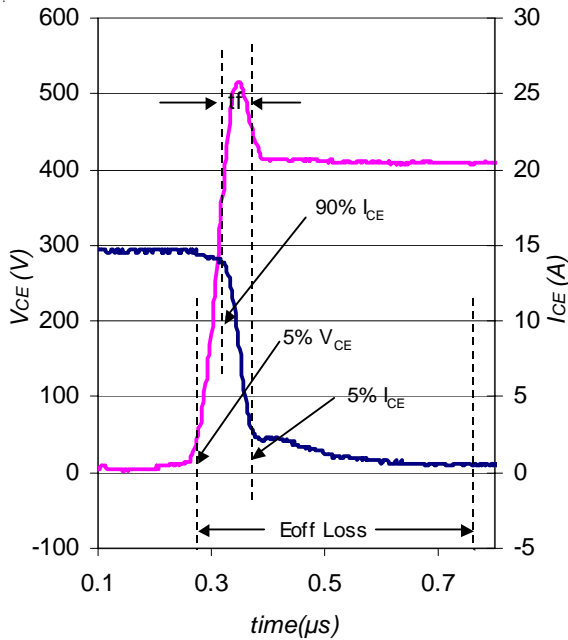


Fig. WF1- Typ. Turn-off Loss Waveform  
@  $T_J = 150^\circ C$  using Fig. CT.4

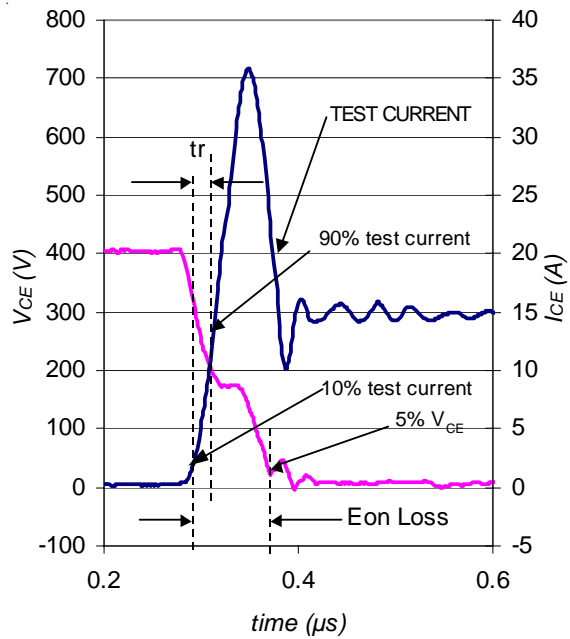


Fig. WF2- Typ. Turn-on Loss Waveform  
@  $T_J = 150^\circ C$  using Fig. CT.4

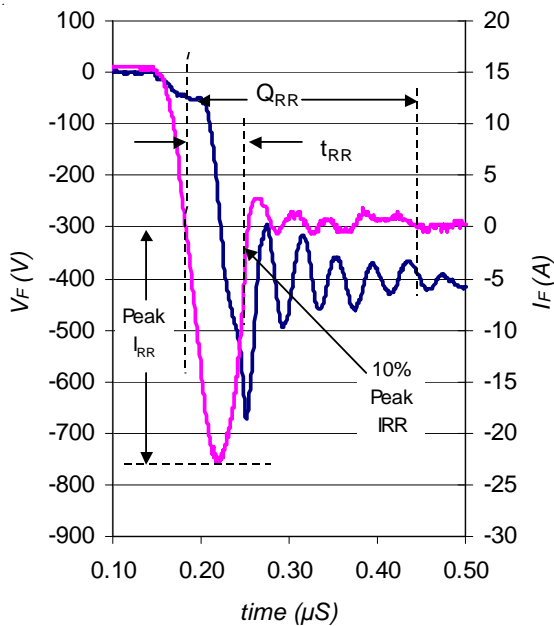


Fig. WF3- Typ. Diode Recovery Waveform  
@  $T_J = 150^\circ C$  using Fig. CT.4

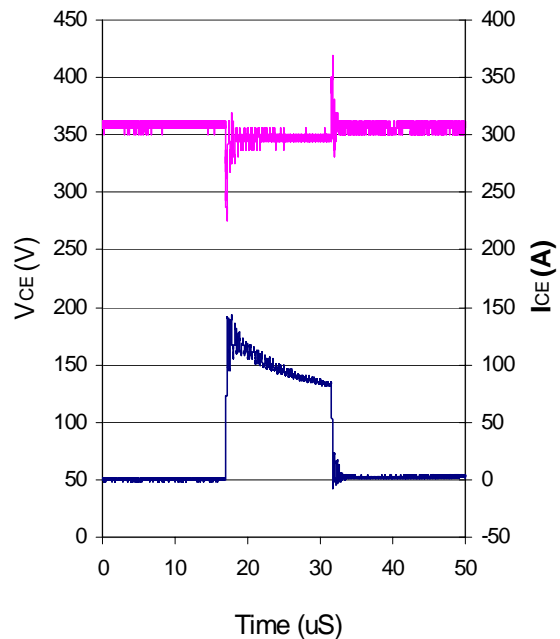


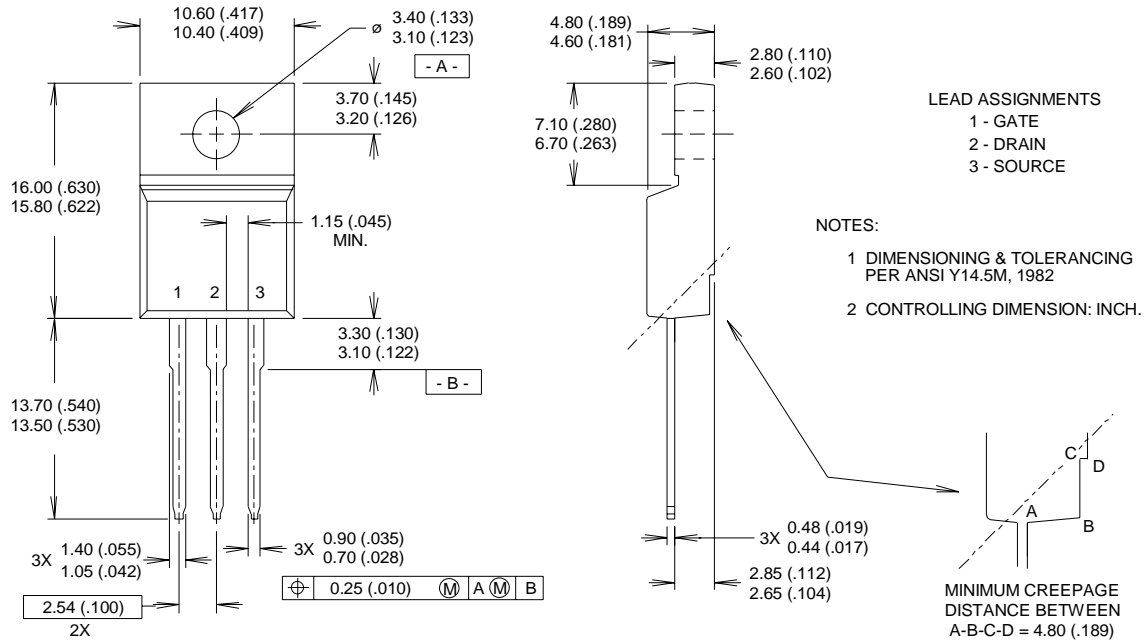
Fig. WF4- Typ. S.C. Waveform  
@  $T_C = 150^\circ C$  using Fig. CT.3

# IRGIB15B60KD1

## TO-220 Full-Pak Package Outline

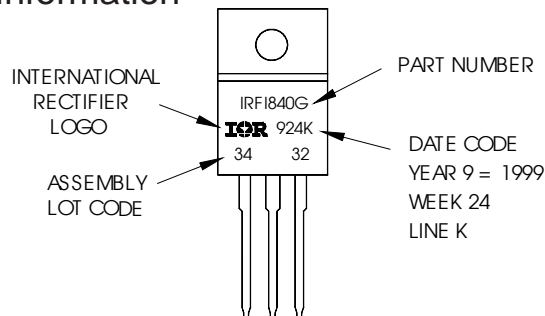
International  
**IR** Rectifier

Dimensions are shown in millimeters (inches)



## TO-220 Full-Pak Part Marking Information

EXAMPLE: THIS IS AN IRF1840G  
 WITH ASSEMBLY  
 LOT CODE 3432  
 ASSEMBLED ON WW 24 1999  
 IN THE ASSEMBLY LINE "K"



**TO-220 FullPak packages are not recommended for Surface Mount Application.**

Data and specifications subject to change without notice.  
 This product has been designed and qualified for the Industrial market.  
 Qualification Standards can be found on IR's Web site.

International  
**IR** Rectifier

**IR WORLD HEADQUARTERS:** 233 Kansas St., El Segundo, California 90245, USA Tel: (310) 252-7105  
 TAC Fax: (310) 252-7903

Visit us at [www.irf.com](http://www.irf.com) for sales contact information.2/04

[www.irf.com](http://www.irf.com)